

Series A & L Rod Gland Kits

Series A & L Cylinders Nitrile	Series L Cylinders Urethane	Series A & L Cylinders Fluorocarbon	Series A & L Cylinders Bronze
--------------------------------------	-----------------------------------	---	-------------------------------------

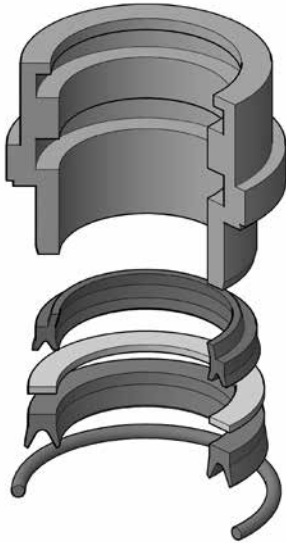

Kit Includes:

- 1 Bronze Gland
- 1 XNBR Wiper
- 1 PTFE Back-Up Ring
- 1 NBR U-Seal
- 1 NBR O-Ring

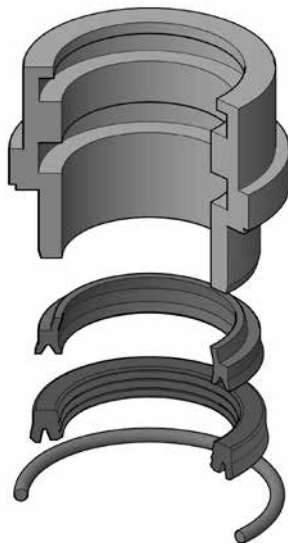

Kit Includes:

- 1 Bronze Gland
- 1 XNBR Wiper
- 1 Multi-lip Urethane U-Seal
- 1 NBR O-Ring

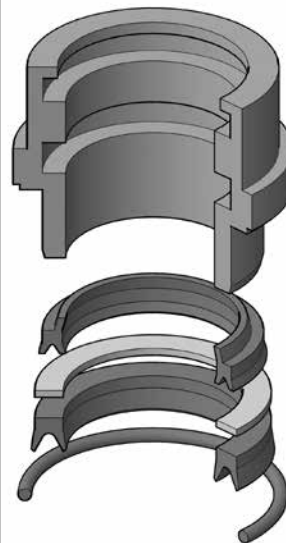

Kit Includes:

- 1 Bronze Gland
- 1 FC Wiper
- 1 PTFE Back-Up Ring
- 1 FC U-Seal
- 1 FC O-Ring

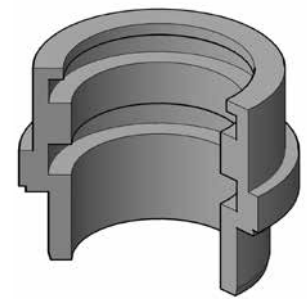

Kit Includes:

- 1 Bronze Gland

Rod Dia.	(NBR) Kit #	List Price	(URE) Kit #	List Price	(FC) Kit #	List Price	(BZ) Kit #	List Price
5/8"	ATL-4A06R000S	\$102.14	ATL-EA06R000S	\$106.40	ATL-4A06R000V	\$135.63	ATL-RGAL-06	\$89.59
1"	ATL-4A10R000S	120.20	ATL-EA10R000S	118.99	ATL-4A10R000V	159.39	ATL-RGAL-10	100.62
1-3/8"	ATL-4A13R000S	143.99	ATL-EA13R000S	136.77	ATL-4A13R000V	164.50	ATL-RGAL-13	117.96
1-3/4"	ATL-4A17R000S	169.75	ATL-EA17R000S	161.50	ATL-4A17R000V	195.66	ATL-RGAL-17	137.74
2"	ATL-4A20R000S	199.14	ATL-EA20R000S	198.17	ATL-4A20R000V	228.98	ATL-RGAL-20	167.09
2-1/2"	ATL-4A25R000S	226.52	ATL-EA25R000S	222.68	ATL-4A25R000V	272.50	ATL-RGAL-25	188.65
3"	ATL-4A30R000S	279.77	ATL-EA30R000S	296.57	ATL-4A30R000V	329.92	ATL-RGAL-30	234.77

Series 2LA Rod Gland Kits

Nitrile Series 2LA Air Cylinders Fluorocarbon

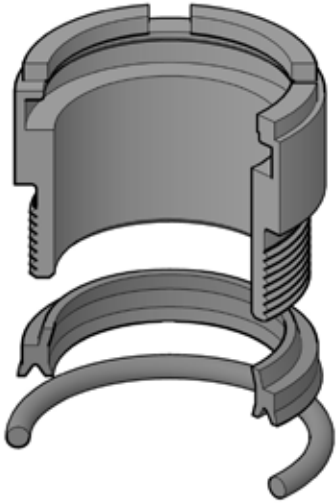

1/2" - 1-3/4"

Kit Includes:

- 1 Bronze gland
- 1 XNBR Wiper/Seal
- 1 NBR O-Ring
- 1 Tube Seal Lubricant

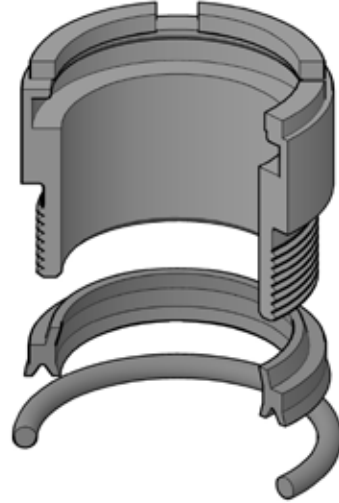

1/2" - 1-3/4"

Kit Includes:

- 1 Bronze gland
- 1 FC Wiper/Seal
- 1 FC O-Ring
- 1 Tube Seal Lubricant

Rod Dia.	(NBR) Kit #	List Price	(FC) Kit #	List Price
1/2"	ATL-RG02MA0051	\$46.89	ATL-RG02MA0055	\$49.96
5/8"	ATL-RG02MA0061	30.98	ATL-RG02MA0065	49.47
1"	ATL-RG02MA0101	35.49	ATL-RG02MA0105	54.82
1-3/8"	ATL-RG02MA0131	53.00	ATL-RG02MA0135	79.24
1-3/4"	ATL-RG02MA0171	107.87	ATL-RG02MA0175	121.00

ATLAS

Series A & L Rod Seal Kits

Series A Cylinders Nitrile



Kit Includes:

- 1 XNBR Wiper
- 1 PTFE Back-up Ring
- 1 NBR U-Seal
- 1 NBR O-Ring

Series L Cylinders Urethane



Kit Includes:

- 1 XNBR Wiper
- 1 Multi-lip Urethane U-Seal
- 1 NBR O-Ring

Series A & L Cylinders Fluorocarbon



Kit Includes:

- 1 FC Wiper
- 1 PTFE Back-up Ring
- 1 FC U-Seal
- 1 FC O-Ring

Rod Dia.	(NBR) Kit #	List Price	(URE) Kit #	List Price	(FC) Kit #	List Price
5/8"	ATL-4A06S000S	\$11.64	ATL-EA06S000S	\$9.81	ATL-4A06S000V	\$32.33
3/4"	ATL-4A07S000S	15.69	—		ATL-4A07S000V	46.40
1"	ATL-4A10S000S	11.66	ATL-EA10S000S	10.56	ATL-4A10S000V	33.34
1-3/8"	ATL-4A13S000S	11.95	ATL-EA13S000S	11.26	ATL-4A13S000V	35.06
1-3/4"	ATL-4A17S000S	15.06	ATL-EA17S000S	13.18	ATL-4A17S000V	39.30
2"	ATL-4A20S000S	16.82	ATL-EA20S000S	16.99	ATL-4A20S000V	40.93
2-1/2"	ATL-4A25S000S	22.90	ATL-EA25S000S	19.41	ATL-4A25S000V	51.74
3"	ATL-4A30S000S	32.70	ATL-EA30S000S	39.35	ATL-4A30S000V	60.77
3-1/2"	ATL-4A35S000S	35.77	ATL-EA35S000S	56.98	ATL-4A35S000V	75.57
4"	ATL-4A40S000S	38.39	ATL-EA40S000S	63.50	ATL-4A40S000V	115.66
4-1/2"	ATL-4A45S000S	46.89	ATL-EA45S000S	70.61	ATL-4A45S000V	130.42
5"	ATL-4A50S000S	54.67	ATL-EA50S000S	76.60	ATL-4A50S000V	175.41

Series 2LA Rod Kits

Nitrile Series 2LA Air Cylinders Fluorocarbon

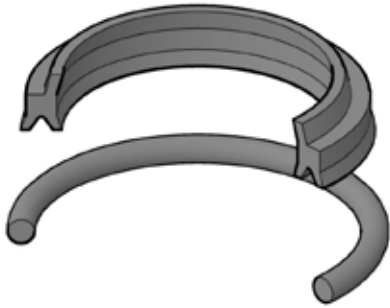

1/2" - 1-3/4"

Kit Includes:

- 1 XNBR Wiper/Seal
- 1 NBR O-Ring
- 1 Tube Seal Lubricant

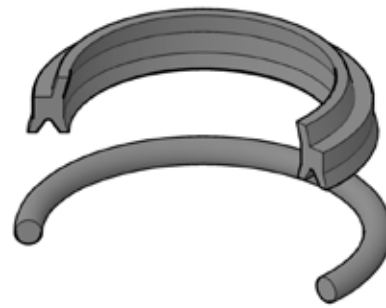

1/2" - 1-3/4"

Kit Includes:

- 1 FC Wiper/Seal
- 1 FC O-Ring
- 1 Tube Seal Lubricant

Rod Dia.	(NBR) Kit #	List Price	(FC) Kit #	List Price
1/2"	ATL-RK02MA0051	\$15.13	ATL-RK02MA0055	\$22.62
5/8"	ATL-RK02MA0061	15.60	ATL-RK02MA0065	23.24
1"	ATL-RK02MA0101	16.00	ATL-RK02MA0105	24.00
1-3/8"	ATL-RK02MA0131	17.12	ATL-RK02MA0135	30.05
1-3/4"	ATL-RK02MA0171	18.29	ATL-RK02MA0175	37.79

Series A & L Piston Kits

Series A Cylinders Nitrile

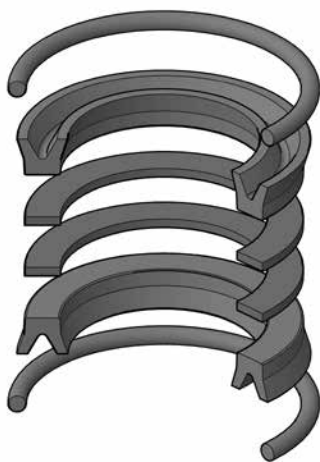

Kit Includes:

- 2 NBR U-Seals
- 2 HP URE Back-Up Rings
- 2 NBR O-Ring Head Seals

Series L Cylinders Nitrile

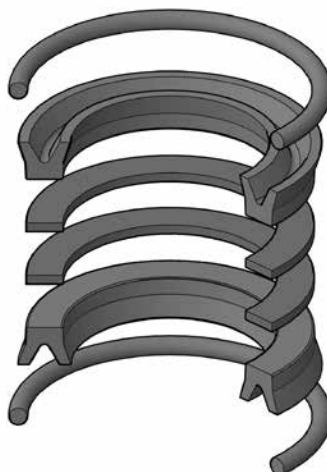

Kit Includes:

- 2 NBR U-Seals
- 2 HP URE Back-Up Rings
- 2 NBR O-Ring Head Seals

Series A & L Cylinders Fluorocarbon



Kit Includes:

- 2 FC U-Seals
- 2 HP URE Back-Up Rings
- 2 FC O-Ring head Seals

Bore Dia.	(NBR) Kit #	List Price	(NBR) Kit #	List Price	(FC) Kit #	List Price
1-1/2"	ATL-4B00S015S	\$9.38	ATL-EB00S015S	\$9.38	ATL-4B00S015V	\$43.10
2"	ATL-4B00S020S	11.18	ATL-EB00S020S	11.18	ATL-4B00S020V	49.27
2-1/2"	ATL-4B00S025S	12.81	ATL-EB00S025S	12.81	ATL-4B00S025V	68.25
3-1/4"	ATL-4B00S032S	15.55	ATL-EB00S032S	15.55	ATL-4B00S032V	73.29
4"	ATL-4B00S040S	19.80	ATL-EB00S040S	19.80	ATL-4B00S040V	86.92
5"	ATL-4B00S050S	23.97	ATL-EB00S050S	23.97	ATL-4B00S050V	107.80
6"	ATL-4B00S060S	31.15	ATL-EB00S060S	31.15	ATL-4B00S060V	148.25
7"	ATL-4B00S070S	86.87	ATL-4B00S070S	86.87	ATL-4B00S070V	268.04
8"	ATL-4B00S080S	98.54	ATL-EB00S080S	98.54	ATL-4B00S080V	323.16
10"	ATL-4B00S100S	140.28	ATL-4B00S100S	140.28	ATL-4B00S100V	447.84
12"	ATL-4B00S120S	189.84	ATL-4B00S120S	189.84	ATL-4B00S120V	695.11
14"	ATL-4B00S140S	293.93	ATL-4B00S140S	293.93	ATL-4B00S140V	1024.71

HP URE - High Performance Urethane

Series 2LA Piston Kits

Series 2LA Air Cylinders

Nitrile

Fluorocarbon

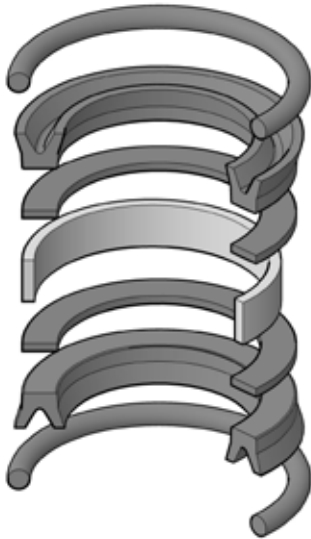

Kit Includes:

- 2 NBR O-ring Head Seals
- 2 NBR U-Seals
- 2 URE Back-up Rings
- 1 Nylon Wear Ring
- 1 Tube Seal Lubricant

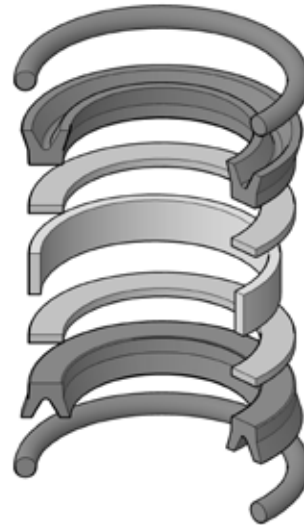

Kit Includes:

- 2 FC O-ring Head Seals
- 2 FC U-Seals
- 2 PTFE Back-up Rings
- 1 Nylon Wear Ring
- 1 Tube Seal Lubricant

Bore Dia.	(NBR) Kit #	List Price	(FC) Kit #	List Price
1-1/2"	ATL-PK1502MA01	\$28.21	ATL-PK1502MA05	\$54.96
2"	ATL-PK2002MA01	28.59	ATL-PK2002MA05	58.86
2-1/2"	ATL-PK2502MA01	30.66	ATL-PK2502MA05	78.13
3-1/4"	ATL-PK3202MA01	36.86	ATL-PK3202MA05	96.58
4"	ATL-PK4002MA01	45.19	ATL-PK4002MA05	109.41
5"	ATL-PK5002MA01	58.47	ATL-PK5002MA05	165.56
6"	ATL-PK6002MA01	78.18	ATL-PK6002MA05	234.50
8"	ATL-PK8002MA01	138.02	ATL-PK8002MA05	392.11

ATLAS

Series A & L Head Seal Kits

Nitrile

Series A & L Head Seal Kits

Fluorocarbon

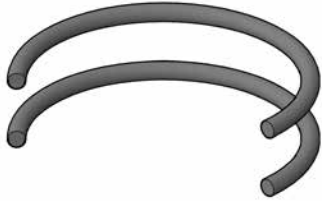

Kit Includes:
2 NBR O-Ring Head Seals

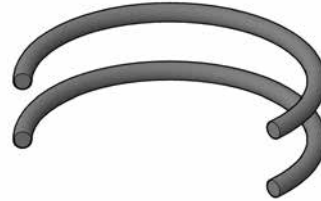

Kit Includes:
2 FC O-Ring Head Seals

Bore Dia.	(NBR) Kit #	List Price	(FC) Kit #	List Price
1-1/2"	ATL-4E00S015S	\$5.44	ATL-4E00S015V	\$7.82
2"	ATL-4E00S020S	5.78	ATL-4E00S020V	13.29
2-1/2"	ATL-4E00S025S	6.45	ATL-4E00S025V	17.42
3-1/4"	ATL-4E00S032S	6.53	ATL-4E00S032V	20.34
4"	ATL-4E00S040S	6.86	ATL-4E00S040V	26.19
5"	ATL-4E00S050S	8.01	ATL-4E00S050V	36.86
6"	ATL-4E00S060S	9.92	ATL-4E00S060V	38.87
7"	ATL-4E00S070S	10.06	ATL-4E00S070V	54.94
8"	ATL-4E00S080S	12.24	ATL-4E00S080V	55.11
10"	ATL-4E00S100S	14.20	ATL-4E00S100V	61.37
12"	ATL-4E00S120S	16.38	ATL-4E00S120V	74.01
14"	ATL-4E00S140S	82.86	ATL-4E00S140V	148.60

ATLAS

Series H Rod Seal Kits

Nitrile

Series H Rod Seal Kits

Fluorocarbon



Kit Includes:

- 1 URE Wiper (For cyl. mfg. before April 2005)
- 1 XNBR Wiper (For cyl. mfg. April 2005 and after)
- 1 Multi-lip URE U-Seal
- 1 NBR O-Ring

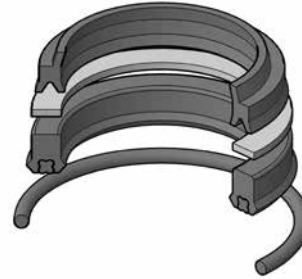

Kit Includes:

- 1 FC Wiper (For cyl. mfg. April 2005 and after*)
- 1 PTFE Back-Up Rings
- 1 FC Loaded FC U-Seals
- 1 FC O-Ring

Rod Dia.	(NBR) Kit #	List Price	(FC) Kit #	List Price
5/8"	ATL-PH06SH000	\$10.54	ATL-VH06SH000	\$32.19
1"	ATL-PH10SH000	11.38	ATL-VH10SH000	45.42
1-3/8"	ATL-PH13SH000	15.29	ATL-VH13SH000	47.38
1-3/4"	ATL-PH17SH000	15.44	ATL-VH17SH000	56.18
2"	ATL-PH20SH000	21.12	ATL-VH20SH000	64.33
2-1/2"	ATL-PH25SH000	26.32	ATL-VH25SH000	103.98
3"	ATL-PH30SH000	27.94	ATL-VH30SH000	119.81
3-1/2"	ATL-PH35SH000	54.05	ATL-VH35SH000	166.56

* Fluorocarbon Rod Seal Kits for cylinders manufactured before April 2005 use a bronze AN style wiper ring.

Series H (for cylinders manufactured before April 2005) Piston Seal Kits

Nitrile

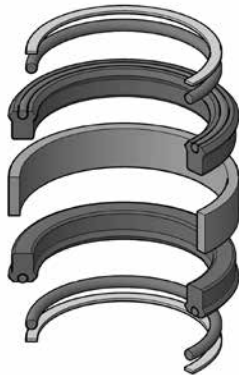

Kit Includes:

- * See notes below
- 2 NBR Loaded URE U-Seals
- 1 Nylon Wear Ring
- 2 NBR O-Ring Head Seals
- 2 PTFE Back-up Rings

Series H Piston Seal Kits

Fluorocarbon

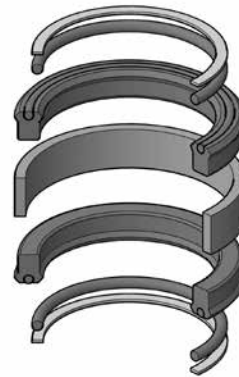

Kit Includes:

- * See notes below
- 2 FC Loaded FC U-Seals
- 1 Nylon Wear Ring
- 2 FC O-Ring Head Seals
- 2 PTFE Back-Up Rings

Bore Dia.	(NBR) Kit #	List Price	(FC) Kit #	List Price
1-1/2"	ATL-1B00S015S	\$19.52	ATL-1B00S015V	\$59.14
2"	ATL-1B00S020S	22.74	ATL-1B00S020V	65.82
2-1/2"	ATL-1B00S025S	24.28	ATL-1B00S025V	69.87
3-1/4"	ATL-1B00S032S	37.39	ATL-1B00S032V	99.81
4"	ATL-1B00S040S	47.96	ATL-1B00S040V	143.83
5"	ATL-1B00S050S	100.79	ATL-1B00S050V	216.56
6"	ATL-1B00S060S	172.69	ATL-1B00S060V	293.95
7"	ATL-1B00S070S	225.65	ATL-1B00S070V	451.45
8"	ATL-1B00S080S	239.49	ATL-1B00S080V	474.00
10"	ATL-1B00S100S	313.09	ATL-1B00S100V	628.18
12"	ATL-1B00S120S	397.85	ATL-1B00S120V	771.40

* Kit contents are size dependant:
 1-1/2" thru 4" - U-Seals and O-Rings
 5" - U-Seals, O-Rings and Wear Rings
 6" - Same as 5, also includes 2 PTFE U-Seal Back-Up Rings
 7" thru 12" - contain all parts listed

(for cylinders manufactured April 2005 and after) **Series H**
Piston Seal Kits
 (1-1/2" to 6" Bores)

Series H Piston Seal Kits

Nitrile



Kit Includes:
 2 NBR O-Ring Head Seals
 2 HP URE Back-up Rings
 2 NBR U-Seals

Fluorocarbon



Kit Includes:
 2 FC O-Ring Head Seals
 2 PTFE Back-Up Rings
 2 FC U-Seals

Bore Dia.	(NBR) Kit #	List Price	(FC) Kit #	List Price
1-1/2"	ATL-PH00LH015	\$15.07	ATL-VH00LH015	\$52.99
2"	ATL-PH00LH020	15.93	ATL-VH00LH020	76.36
2-1/2"	ATL-PH00LH025	18.93	ATL-VH00LH025	87.93
3-1/4"	ATL-PH00LH032	34.63	ATL-VH00LH032	101.56
4"	ATL-PH00LH040	41.19	ATL-VH00LH040	232.24
5"	ATL-PH00LH050	60.52	ATL-VH00LH050	348.90
6"	ATL-PH00LH060	90.57	ATL-VH00LH060	410.24

HP URE - High Performance Urethane

Series H (for cylinders manufactured April 2005 and after) Piston Seal Kits (7" & 8" Bores)

Nitrile

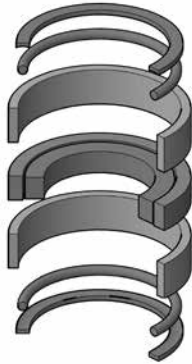

- Kit Includes:**
 2 NBR Back-Up Rings
 2 NBR O-Ring Head Seals
 2 Nylon Wear Rings
 1 Bronze filled PTFE Piston Ring
 w/ 1 NBR Expander

Series H Piston Seal Kits

Fluorocarbon

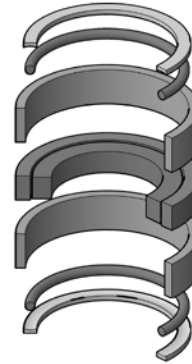

- Kit Includes:**
 2 PTFE Back-Up Rings
 2 FC O-Ring Head Seals
 2 Nylon Wear Rings
 1 Bronze filled PTFE Piston Ring
 w/1 FC Expander

Bore Dia.	(NBR) Kit #	List Price	(FC) Kit #	List Price
7"	ATL-PH00KH070	\$364.80	ATL-VH00KH070	\$369.01
8"	ATL-PH00KH080	443.40	ATL-VH00KH080	455.30

High load Piston Seal Kits are standard for 7" & 8" Bores

(for cylinders manufactured before April 2005) **Series H
Head Seal Kits**

Series H Head Seal Kits

Nitrile



Kit Includes:
2 NBR O-Ring Head Seals
2 PTFE Back-up Rings*

Fluorocarbon

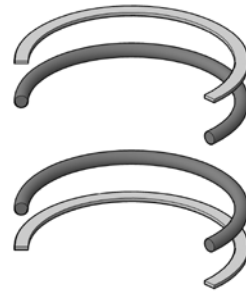

Kit Includes:
2 FC O-Ring Head Seals
2 PTFE Back-up Rings*

Bore Dia.	(NBR) Kit #	List Price	(FC) Kit #	List Price
1-1/2"	ATL-1E00S015S	\$4.76	ATL-1E00S015V	\$7.07
2"	ATL-1E00S020S	6.10	ATL-1E00S020V	8.41
2-1/2"	ATL-1E00S025S	8.17	ATL-1E00S025V	10.10
3-1/4"	ATL-1E00S032S	15.26	ATL-1E00S032V	19.95
4"	ATL-1E00S040S	18.45	ATL-1E00S040V	21.58
5"	ATL-1E00S050S	22.12	ATL-1E00S050V	33.58
6"	ATL-1E00S060S	34.71	ATL-1E00S060V	36.26
7"	ATL-1E00S070S	73.54	ATL-1E00S070V	85.50
8"	ATL-1E00S080S	78.21	ATL-1E00S080V	99.78
10"	ATL-1E00S100S	142.22	ATL-1E00S100V	160.18
12"	ATL-1E00S120S	161.64	ATL-1E00S120V	184.39

* Back-up Rings in 7", 8", 10" and 12" kits only

Bronze Rod Glands

Series 2LA Air Cylinders

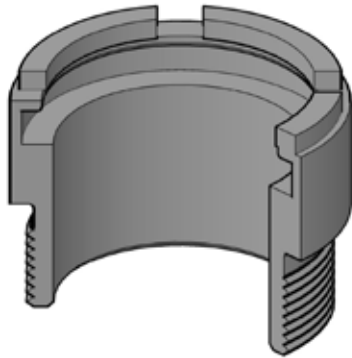

Rod Dia.	Kit #	List Price
1/2"	ATL-RG02MA-05	\$37.59
5/8"	ATL-RG02MA-06	27.70
1"	ATL-RG02MA-10	34.67
1-3/8"	ATL-RG02MA-13	50.12
1-3/4"	ATL-RG02MA-17	78.94

Rod Kits

Hydraulic Cylinders

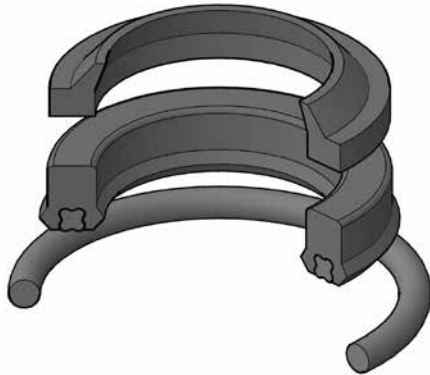

Kit Includes:
 1 URE Wiper
 1 URE Loaded U-seal
 1 NBR O-ring

Rod Dia.	Kit #	List Price
5/8"	ATL-HRK62	\$10.10
1"	ATL-HRK100	12.10
1-3/8"	ATL-HRK137	14.03
1-3/8"	ATL-90030340-79	16.38
1-3/8"	ATL-90030370-79	13.43
1-3/4"	ATL-HRK175	15.52
1-3/4"	ATL-90030340-69	14.65
1-3/4"	ATL-90030370-69	14.53
2"	ATL-HRK200	16.63

Piston Kits

Pneumatic Cylinders

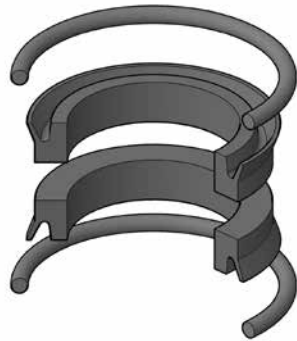

Kit Includes:
 2 URE U-seals
 2 NBR O-rings

Bore Dia.	Kit #	List Price
1-1/2"	—	
2"	ATL-APK20-000	\$15.28
2-1/2"	ATL-APK25-000	16.15
3-1/4"	—	
4"	ATL-APK40-000	44.43
5"	ATL-APK50-000	44.79
6"	ATL-APK60-000	52.80
8"	ATL-APK80-000	90.66
10"	ATL-APK100-000	176.51

Hydraulic Cylinders

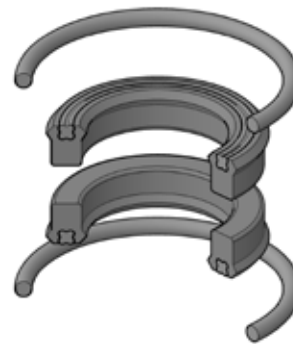

Kit Includes:
 2 URE Loaded U-seals
 2 NBR O-rings

Kit #	List Price
ATL-HPK15-000	\$17.91
ATL-HPK20-000	20.08
ATL-HPK25-000	21.79
ATL-HPK35-000	32.64
ATL-HPK40-000	39.36
ATL-HPK50-000	48.92
ATL-HPK60-000	58.47
ATL-HPK80-000	118.98
—	

ATLAS

ATLAS

Kit Number	Code	Rod Size	Bore Size	List Price
ATL-1B00S015S	N-N-5		1-1/2	\$19.52
ATL-1B00S015V	N-N-5		1-1/2	59.14
ATL-1B00S020S	N-N-5		2	22.74
ATL-1B00S020V	N-N-5		2	65.82
ATL-1B00S025S	N-N-5		2-1/2	24.28
ATL-1B00S025V	N-N-5		2-1/2	69.87
ATL-1B00S032S	N-N-5		3-1/4	37.39
ATL-1B00S032V	N-N-5		3-1/4	99.81
ATL-1B00S040S	N-N-5		4	47.96
ATL-1B00S040V	N-N-5		4	143.83
ATL-1B00S050S	N-N-5		5	100.79
ATL-1B00S050V	N-N-5		5	216.56
ATL-1B00S060S	N-N-5		6	172.69
ATL-1B00S060V	N-N-5		6	293.95
ATL-1B00S070S	N-N-5		7	225.65
ATL-1B00S070V	N-N-5		7	451.45
ATL-1B00S080S	N-N-5		8	239.49
ATL-1B00S080V	N-N-5		8	474.00
ATL-1B00S100S	N-N-5		10	313.09
ATL-1B00S100V	N-N-5		10	628.18
ATL-1B00S120S	N-N-5		12	397.85
ATL-1B00S120V	N-N-5		12	771.40
ATL-1E00S015S	Head Seal Kit		1-1/2	4.76
ATL-1E00S015V	Head Seal Kit		1-1/2	7.07
ATL-1E00S020S	Head Seal Kit		2	6.10
ATL-1E00S020V	Head Seal Kit		2	8.41
ATL-1E00S025S	Head Seal Kit		2-1/2	8.17
ATL-1E00S025V	Head Seal Kit		2-1/2	10.10
ATL-1E00S032S	Head Seal Kit		3-1/4	15.26
ATL-1E00S032V	Head Seal Kit		3-1/4	19.95
ATL-1E00S040S	Head Seal Kit		4	18.45
ATL-1E00S040V	Head Seal Kit		4	21.58
ATL-1E00S050S	Head Seal Kit		5	22.12
ATL-1E00S050V	Head Seal Kit		5	33.58
ATL-1E00S060S	Head Seal Kit		6	34.71
ATL-1E00S060V	Head Seal Kit		6	36.26
ATL-1E00S070S	Head Seal Kit		7	73.54
ATL-1E00S070V	Head Seal Kit		7	85.50
ATL-1E00S080S	Head Seal Kit		8	78.21
ATL-1E00S080V	Head Seal Kit		8	99.78
ATL-1E00S100S	Head Seal Kit		10	142.22
ATL-1E00S100V	Head Seal Kit		10	160.18
ATL-1E00S120S	Head Seal Kit		12	161.64
ATL-1E00S120V	Head Seal Kit		12	184.39
ATL-4A06R000S	I-U-1	5/8		102.14
ATL-4A06R000V	I-U-1	5/8		135.63
ATL-4A06S000S	I-U-1	5/8		11.64
ATL-4A06S000V	I-U-1	5/8		32.33
ATL-4A07S000S	I-U-1	3/4		15.69
ATL-4A07S000V	I-U-1	3/4		46.40

Kit Number	Code	Rod Size	Bore Size	List Price
ATL-4A10R000S	I-U-1	1		\$120.20
ATL-4A10R000V	I-U-1	1		159.39
ATL-4A10S000S	I-U-1	1		11.66
ATL-4A10S000V	I-U-1	1		33.34
ATL-4A13R000S	I-U-1	1-3/8		143.99
ATL-4A13R000V	I-U-1	1-3/8		164.50
ATL-4A13S000S	I-U-1	1-3/8		11.95
ATL-4A13S000V	I-U-1	1-3/8		35.06
ATL-4A17R000S	I-U-1	1-3/4		169.75
ATL-4A17R000V	I-U-1	1-3/4		195.66
ATL-4A17S000S	I-U-1	1-3/4		15.06
ATL-4A17S000V	I-U-1	1-3/4		39.30
ATL-4A20R000S	I-U-1	2		199.14
ATL-4A20R000V	I-U-1	2		228.98
ATL-4A20S000S	I-U-1	2		16.82
ATL-4A20S000V	I-U-1	2		40.93
ATL-4A25R000S	I-U-1	2-1/2		226.52
ATL-4A25R000V	I-U-1	2-1/2		272.50
ATL-4A25S000S	I-U-1	2-1/2		22.90
ATL-4A25S000V	I-U-1	2-1/2		51.74
ATL-4A30R000S	I-U-1	3		279.77
ATL-4A30R000V	I-U-1	3		329.92
ATL-4A30S000S	I-U-1	3		32.70
ATL-4A30S000V	I-U-1	3		60.77
ATL-4A35S000S	I-U-1	3-1/2		35.77
ATL-4A35S000V	I-U-1	3-1/2		75.57
ATL-4A40S000S	I-U-1	4		38.39
ATL-4A40S000V	I-U-1	4		115.66
ATL-4A45S000S	I-U-1	4-1/2		46.89
ATL-4A45S000V	I-U-1	4-1/2		130.42
ATL-4A50S000S	I-U-1	5		54.67
ATL-4A50S000V	I-U-1	5		175.41
ATL-4B00S015S	N-N-5		1-1/2	9.38
ATL-4B00S015V	N-N-5		1-1/2	43.10
ATL-4B00S020S	N-N-5		2	11.18
ATL-4B00S020V	N-N-5		2	49.27
ATL-4B00S025S	N-N-5		2-1/2	12.81
ATL-4B00S025V	N-N-5		2-1/2	68.25
ATL-4B00S032S	N-N-5		3-1/4	15.55
ATL-4B00S032V	N-N-5		3-1/4	73.29
ATL-4B00S040S	N-N-5		4	19.80
ATL-4B00S040V	N-N-5		4	86.92
ATL-4B00S050S	N-N-5		5	23.97
ATL-4B00S050V	N-N-5		5	107.80
ATL-4B00S060S	N-N-5		6	31.15
ATL-4B00S060V	N-N-5		6	148.25
ATL-4B00S070S	N-N-5		7	86.87
ATL-4B00S070V	N-N-5		7	268.04
ATL-4B00S080S	N-N-5		8	98.54
ATL-4B00S080V	N-N-5		8	323.16

ATLAS

Kit Number	Code	Rod Size	Bore Size	List Price
ATL-4B00S100S	N-N-5		10	\$140.28
ATL-4B00S100V	N-N-5		10	447.84
ATL-4B00S120S	N-N-5		12	189.84
ATL-4B00S120V	N-N-5		12	695.11
ATL-4B00S140S	N-N-5		14	293.93
ATL-4B00S140V	N-N-5		14	1024.71
ATL-4E00S015S	Head Seal Kit		1-1/2	5.44
ATL-4E00S015V	Head Seal Kit		1-1/2	7.82
ATL-4E00S020S	Head Seal Kit		2	5.78
ATL-4E00S020V	Head Seal Kit		2	13.29
ATL-4E00S025S	Head Seal Kit		2-1/2	6.45
ATL-4E00S025V	Head Seal Kit		2-1/2	17.42
ATL-4E00S032S	Head Seal Kit		3-1/4	6.53
ATL-4E00S032V	Head Seal Kit		3-1/4	20.34
ATL-4E00S040S	Head Seal Kit		4	6.86
ATL-4E00S040V	Head Seal Kit		4	26.19
ATL-4E00S050S	Head Seal Kit		5	8.01
ATL-4E00S050V	Head Seal Kit		5	36.86
ATL-4E00S060S	Head Seal Kit		6	9.92
ATL-4E00S060V	Head Seal Kit		6	38.87
ATL-4E00S070S	Head Seal Kit		7	10.06
ATL-4E00S070V	Head Seal Kit		7	54.94
ATL-4E00S080S	Head Seal Kit		8	12.24
ATL-4E00S080V	Head Seal Kit		8	55.11
ATL-4E00S100S	Head Seal Kit		10	14.20
ATL-4E00S100V	Head Seal Kit		10	61.37
ATL-4E00S120S	Head Seal Kit		12	16.38
ATL-4E00S120V	Head Seal Kit		12	74.01
ATL-4E00S140S	Head Seal Kit		14	82.86
ATL-4E00S140V	Head Seal Kit		14	148.60
ATL-90030340-69	I-U-1	1-3/4		14.65
ATL-90030340-79	I-U-1	1-3/8		16.38
ATL-90030370-69	I-U-1	1-3/4		14.53
ATL-90030370-79	I-U-1	1-3/8		13.43
ATL-APK100-000	N-N-5		10	176.51
ATL-APK20-000	N-N-5		2	15.28
ATL-APK25-000	N-N-5		2-1/2	16.15
ATL-APK40-000	N-N-5		4	44.43
ATL-APK50-000	N-N-5		5	44.79
ATL-APK60-000	N-N-5		6	52.80
ATL-APK80-000	N-N-5		8	90.66
ATL-EA06R000S	I-U-1	5/8		106.40
ATL-EA06S000S	I-U-1	5/8		9.81
ATL-EA10R000S	I-U-1	1		118.99
ATL-EA10S000S	I-U-1	1		10.56
ATL-EA13R000S	I-U-1	1-3/8		136.77
ATL-EA13S000S	I-U-1	1-3/8		11.26
ATL-EA17R000S	I-U-1	1-3/4		161.50
ATL-EA17S000S	I-U-1	1-3/4		13.18
ATL-EA20R000S	I-U-1	2		198.17

Kit Number	Code	Rod Size	Bore Size	List Price
ATL-EA20S000S	I-U-1	2		\$16.99
ATL-EA25R000S	I-U-1	2-1/2		222.68
ATL-EA25S000S	I-U-1	2-1/2		19.41
ATL-EA30R000S	I-U-1	3		296.57
ATL-EA30S000S	I-U-1	3		39.35
ATL-EA35S000S	I-U-1	3-1/2		56.98
ATL-EA40S000S	I-U-1	4		63.50
ATL-EA45S000S	I-U-1	4-1/2		70.61
ATL-EA50S000S	I-U-1	5		76.60
ATL-EB00S015S	N-N-5		1-1/2	9.38
ATL-EB00S020S	N-N-5		2	11.18
ATL-EB00S025S	N-N-5		2-1/2	12.81
ATL-EB00S032S	N-N-5		3-1/4	15.55
ATL-EB00S040S	N-N-5		4	19.80
ATL-EB00S050S	N-N-5		5	23.97
ATL-EB00S060S	N-N-5		6	31.15
ATL-4B00S070S	N-N-5		7	86.87
ATL-EB00S080S	N-N-5		8	98.54
ATL-HPK15-000	N-N-5		1-1/2	17.91
ATL-HPK20-000	N-N-5		2	20.08
ATL-HPK25-000	N-N-5		2-1/2	21.79
ATL-HPK35-000	N-N-5		3-1/4	32.64
ATL-HPK40-000	N-N-5		4	39.36
ATL-HPK50-000	N-N-5		5	48.92
ATL-HPK60-000	N-N-5		6	58.47
ATL-HPK80-000	N-N-5		8	118.98
ATL-HRK100	I-U-1	1		12.10
ATL-HRK137	I-U-1	1-3/8		14.03
ATL-HRK175	I-U-1	1-3/4		15.52
ATL-HRK200	I-U-1	2		16.63
ATL-HRK62	I-U-1	5/8		10.10
ATL-PH00KH070	N-N-10		7	364.80
ATL-PH00KH080	N-N-10		8	443.40
ATL-PH00LH015	N-N-5		1-1/2	15.07
ATL-PH00LH020	N-N-5		2	15.93
ATL-PH00LH025	N-N-5		2-1/2	18.93
ATL-PH00LH032	N-N-5		3-1/4	34.63
ATL-PH00LH040	N-N-5		4	41.19
ATL-PH00LH050	N-N-5		5	60.52
ATL-PH00LH060	N-N-5		6	90.57
ATL-PH06SH000	I-U-1	5/8		10.54
ATL-PH10SH000	I-U-1	1		11.38
ATL-PH13SH000	I-U-1	1-3/8		15.29
ATL-PH17SH000	I-U-1	1-3/4		15.44
ATL-PH20SH000	I-U-1	2		21.12
ATL-PH25SH000	I-U-1	2-1/2		26.32
ATL-PH30SH000	I-U-1	3		27.94
ATL-PH35SH000	I-U-1	3-1/2		54.05
ATL-PK1502MA01	N-N-5		1-1/2	28.21
ATL-PK1502MA05	N-N-5		1-1/2	54.96

ATLAS

ATLAS

Kit Number	Code	Rod Size	Bore Size	List Price
ATL-PK2002MA01	N-N-5		2	\$28.59
ATL-PK2002MA05	N-N-5		2	58.86
ATL-PK2502MA01	N-N-5		2-1/2	30.66
ATL-PK2502MA05	N-N-5		2-1/2	78.13
ATL-PK3202MA01	N-N-5		3-1/4	36.86
ATL-PK3202MA05	N-N-5		3-1/4	96.58
ATL-PK4002MA01	N-N-5		4	45.19
ATL-PK4002MA05	N-N-5		4	109.41
ATL-PK5002MA01	N-N-5		5	58.47
ATL-PK5002MA05	N-N-5		5	165.56
ATL-PK6002MA01	N-N-5		6	78.18
ATL-PK6002MA05	N-N-5		6	234.50
ATL-PK8002MA01	N-N-5		8	138.02
ATL-PK8002MA05	N-N-5		8	392.11
ATL-RGAL-06	Bronze Rod Gland	5/8		89.59
ATL-RGAL-10	Bronze Rod Gland	1		100.62
ATL-RGAL-13	Bronze Rod Gland	1-3/8		117.96
ATL-RGAL-17	Bronze Rod Gland	1-3/4		137.74
ATL-RGAL-20	Bronze Rod Gland	2		167.09
ATL-RGAL-25	Bronze Rod Gland	2-1/2		188.65
ATL-RGAL-30	Bronze Rod Gland	3		234.77
ATL-RG02MA0051	I-SP-1	1/2		46.89
ATL-RG02MA0055	I-SP-1	1/2		49.96
ATL-RG02MA0061	I-SP-1	5/8		30.98
ATL-RG02MA0065	I-SP-1	5/8		49.47
ATL-RG02MA0101	I-SP-1	1		35.49
ATL-RG02MA0105	I-SP-1	1		54.82
ATL-RG02MA0131	I-SP-1	1-3/8		53.00
ATL-RG02MA0135	I-SP-1	1-3/8		79.24
ATL-RG02MA0171	I-SP-1	1-3/4		107.87
ATL-RG02MA0175	I-SP-1	1-3/4		121.00
ATL-RG02MA-05	Bronze Rod Gland	1/2		37.59

Kit Number	Code	Rod Size	Bore Size	List Price
ATL-RG02MA-06	Bronze Rod Gland	5/8		\$27.70
ATL-RG02MA-10	Bronze Rod Gland	1		34.67
ATL-RG02MA-13	Bronze Rod Gland	1-3/8		50.12
ATL-RG02MA-17	Bronze Rod Gland	1-3/4		78.94
ATL-RK02MA0051	I-SP-1	1/2		15.13
ATL-RK02MA0055	I-SP-1	1/2		22.62
ATL-RK02MA0061	I-SP-1	5/8		15.60
ATL-RK02MA0065	I-SP-1	5/8		23.24
ATL-RK02MA0101	I-SP-1	1		16.00
ATL-RK02MA0105	I-SP-1	1		24.00
ATL-RK02MA0131	I-SP-1	1-3/8		17.12
ATL-RK02MA0135	I-SP-1	1-3/8		30.05
ATL-RK02MA0171	I-SP-1	1-3/4		18.29
ATL-RK02MA0175	I-SP-1	1-3/4		37.79
ATL-VH00KH070	N-N-1		7	369.01
ATL-VH00KH080	N-N-1		8	455.30
ATL-VH00LH015	N-N-5		1-1/2	52.99
ATL-VH00LH020	N-N-5		2	76.36
ATL-VH00LH025	N-N-5		2-1/2	87.93
ATL-VH00LH032	N-N-5		3-1/4	101.56
ATL-VH00LH040	N-N-5		4	232.24
ATL-VH00LH050	N-N-5		5	348.90
ATL-VH00LH060	N-N-5		6	410.24
ATL-VH06SH000	I-U-1	5/8		32.19
ATL-VH10SH000	I-U-1	1		45.42
ATL-VH13SH000	I-U-1	1-3/8		47.38
ATL-VH17SH000	I-U-1	1-3/4		56.18
ATL-VH20SH000	I-U-1	2		64.33
ATL-VH25SH000	I-U-1	2-1/2		103.98
ATL-VH30SH000	I-U-1	3		119.81
ATL-VH35SH000	I-U-1	3-1/2		166.56